

SmarTeam

SmarTeam

e-Business Collaboration

**From Product Concept to Realization
Over the Web**

Leading through collaboration

The Company

- Founded in 1995, with Headquarters in Tel Aviv, Israel (and main subsidiaries in the US, France, Germany and the UK)
- 75% owned by Dassault Systems
- As of May 2001, over 240 employees with 90 in R&D and 150 in Support, Consulting & Implementation Services, Sales and G&A
- Flagship product: “SmarTeam® ”

The fastest growing PDM company

SmarTeam

Leading through collaboration

Mission Statement

To provide rapidly implemented,
scalable, customizable and affordable
Windows/Web centric information
collaboration solutions for the extended
enterprise

Make it Simple

SmarTeam

Leading through collaboration

Challenges of the Manufacturing Industry

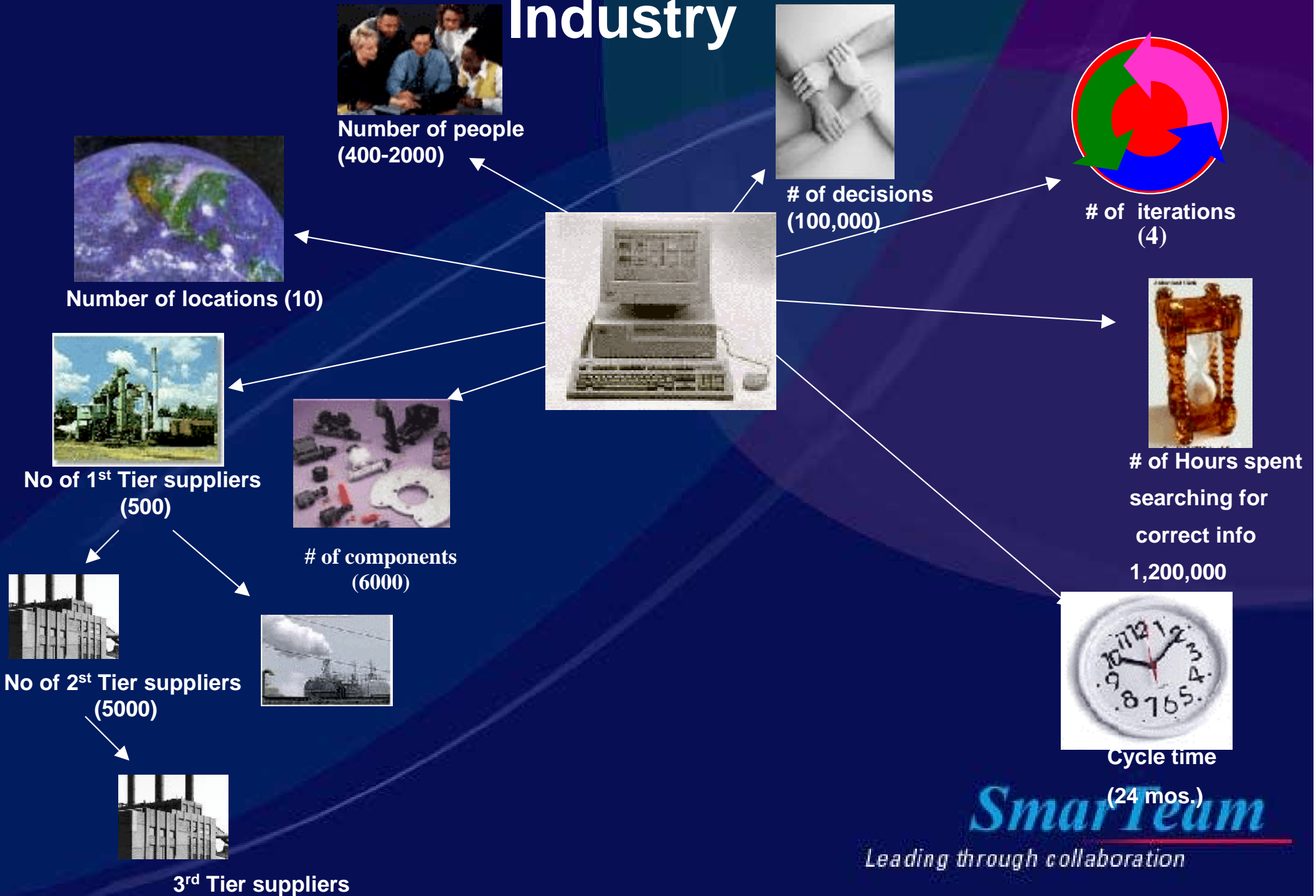

SmartTeam

Leading through collaboration

The extended enterprise collaboration solution



SmarTeam

Leading through collaboration

Value Proposition

- Knowledge capture and re-use
- 3D information sharing
- Control of product changes over the web
- BOM Management and collaboration
- Distributed environment solution for multi-site companies
- Downstream synchronization with ERP/MRP
- Supply chain product information collaboration
- Powerful Enterprise Application Integration (EAI)

SmarTeam

Leading through collaboration

SmarTeam Market Expansion

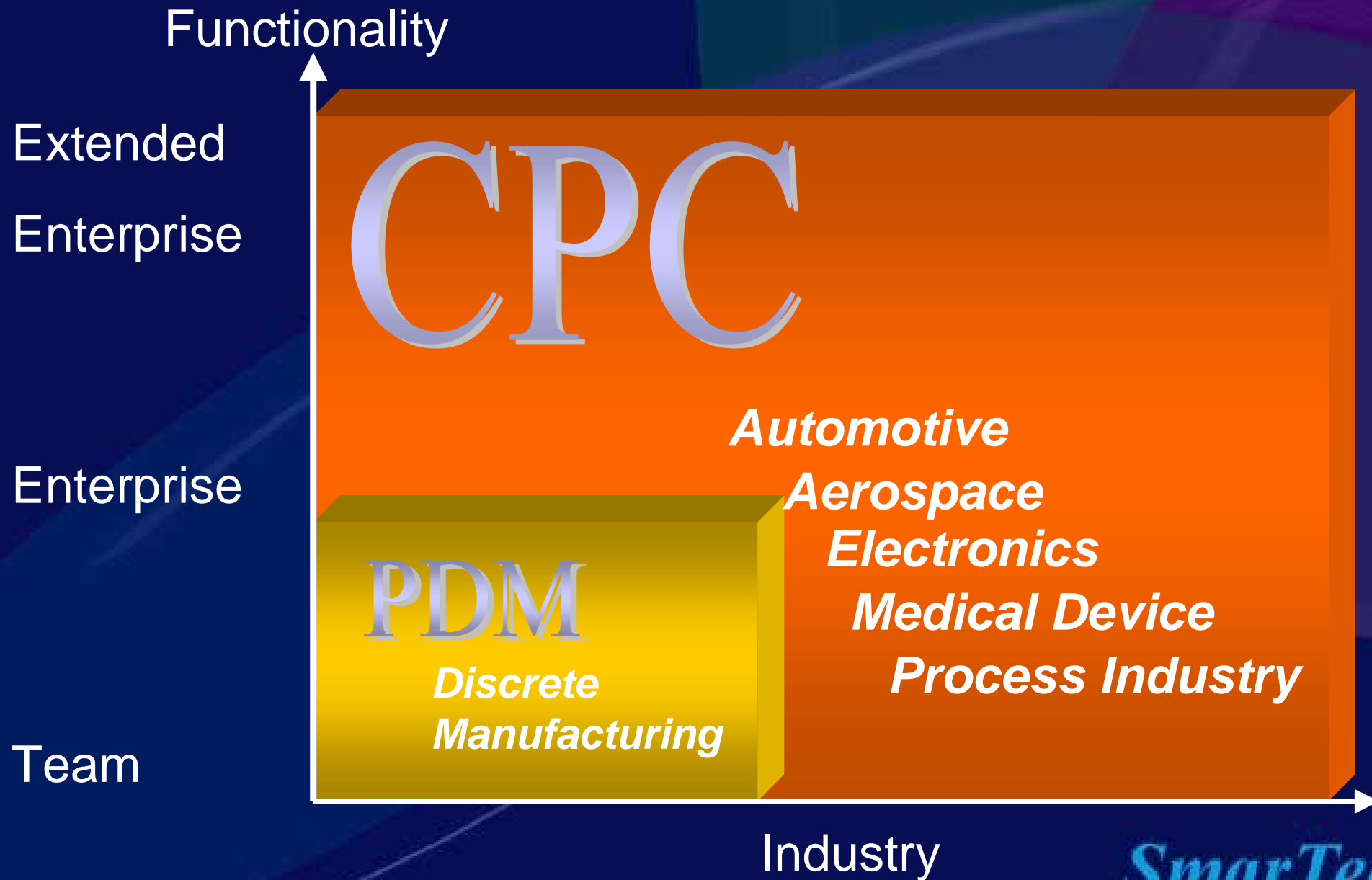

Building Momentum

- Over **150** Value Added Resellers worldwide
- Over **1,400** Customers
- Over **30,000** seats sold

Rapid sales cycles

Rapid Implementation

SmarTeam

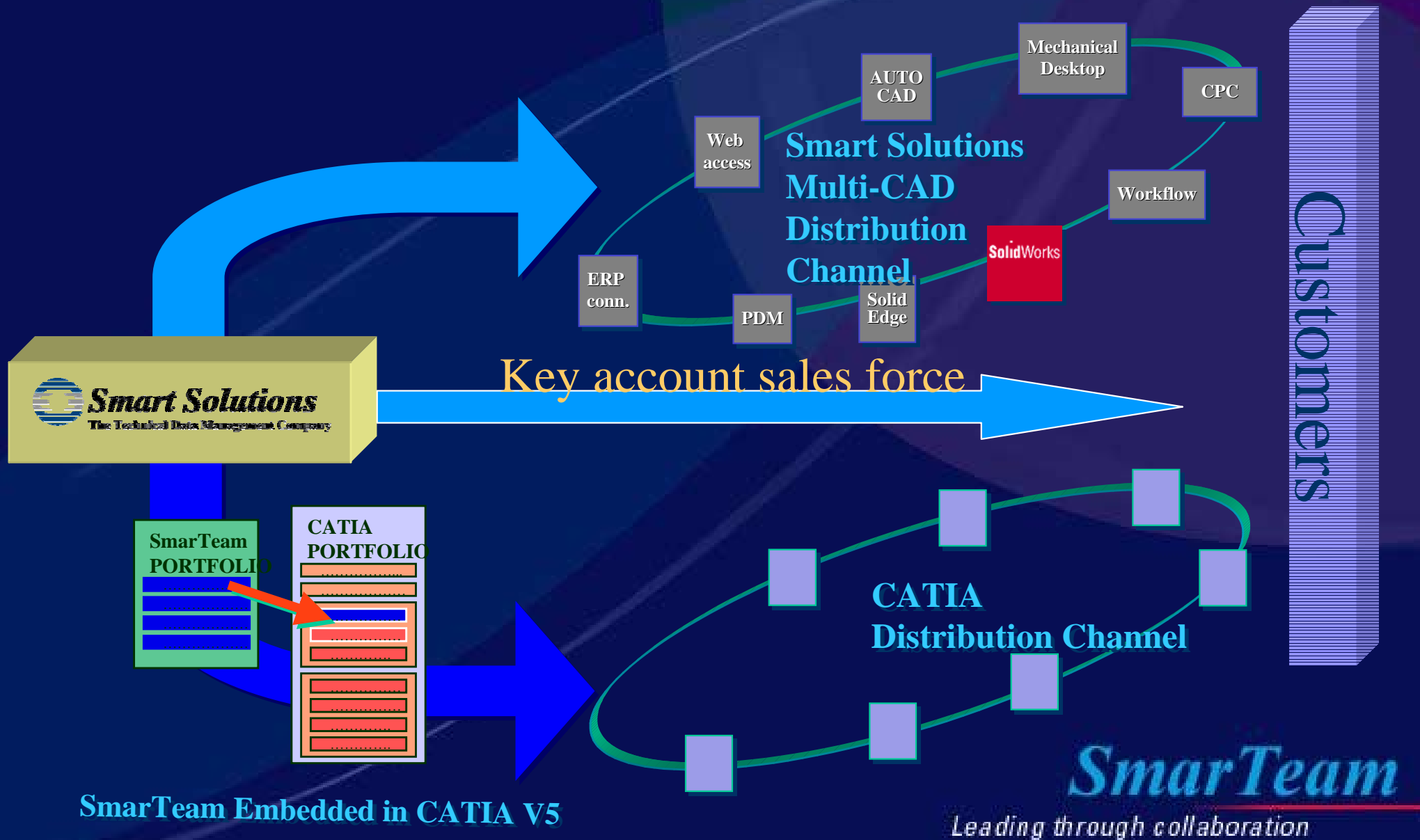

Leading through collaboration

SmarTeam Routes to Market



Global Marketing



 VAR
 Subsidiary

SmarTeam
Leading through collaboration

Some of Our Customers



SmartPartners (Partial List)



SmarTeam

SmarTeam

Products Overview

Leading through collaboration

Collaborative Products and Solutions

Team PDM

- SmartExpress
- SmartDesk
- SmartEdge
- SmartInventor

Enterprise

- SmarTeam
- SmartWeb
- Smart Flow
- SmartERP
- Smart Multi Site

e-Supply Chain

- mySmarTeam
- mySmartPublish
- mySmartMeeting
- SmartBOM
- SmartBriefcase

Everything over the web

SmarTeam

Leading through collaboration

Collaborative Products and Solutions - Team PDM

Team PDM

- SmartExpress
- SmartDesk
- SmartEdge
- SmartInventor

Everything over the web

SmarTeam

Leading through collaboration

Collaborative Products and Solutions - Enterprise

Enterprise

- SmarTeam
- SmartWeb
- Smart Flow
- SmartERP
- Smart Multi Site

Everything over the web

SmarTeam

Leading through collaboration

Collaborative Products and Solutions – eSupply Chain

e-Supply Chain

- mySmarTeam
- mySmartPublish
- mySmartMeeting
- SmartBOM
- SmartBriefcase

Everything over the web

SmarTeam

Leading through collaboration

SmarTeam

SmarTeam PDM Functionality



Leading through collaboration

What is SmarTeam?

- SmarTeam is a business collaboration solution that allows manufacturers to share and exchange product information throughout the enterprise and across the supply chain
- A uniquely cost-effective and rapidly implemented Product Data Management (PDM) solution, SmarTeam also serves as the core of a Collaborative Product Commerce (CPC) enterprise system

SmarTeam

Leading through collaboration

What is SmarTeam? (2)

- Client-Server Windows application
- Focused CAD integrations – SolidWorks, Autodesk Products, Solid Edge, other integrations developed by partners
- Strong customization and tailoring tools – Wizard, User Authorization, Multi-Language support, Form Designer...
- Support distributed locations – Database synchronization, distributed vault support – the multi site solution
- COM API, XML technologies based

SmarTeam

Leading through collaboration

Product Data Management

Manages documents

- Easy search and query mechanism
- Enrich products information: pre-defined and customized attributes

Manages the product structure

- Navigation through linked documents
- Hierarchical links
- Logical links: Documents, projects...

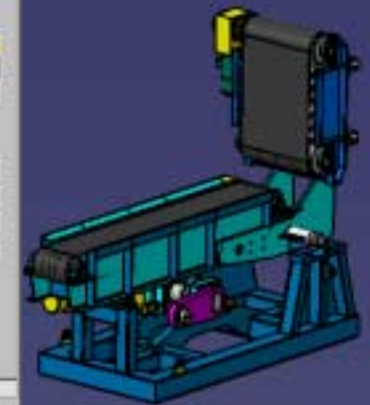
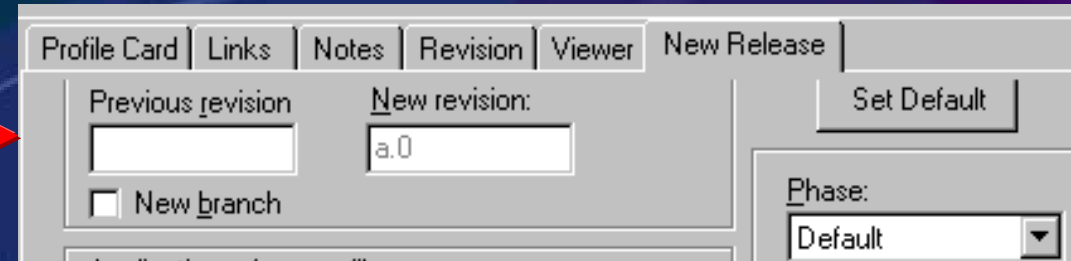

Manages data modifications

- Automatic tracking of revisions with history:
- Major and minor revisions
- Allows and secures team work

Offers a highly secured environment

- Secure Vault
- User security settings

SmarTeam

Leading through collaboration

Enhanced Life Cycle Operations for Concurrent Engineering

- SmarTeam enables users to closely track workflow, revision levels, and other information associated with the product development process. Coordinated check-in/check-out procedures and revision-level management features, enable users to publish their most recent changes to a group while continuing to work on the design.



SmarTeam

Leading through collaboration

Ease-of-Use

Fast to implement

- Through a centralized network installation in silent batch (SMS)
- Ready-to-use templates available

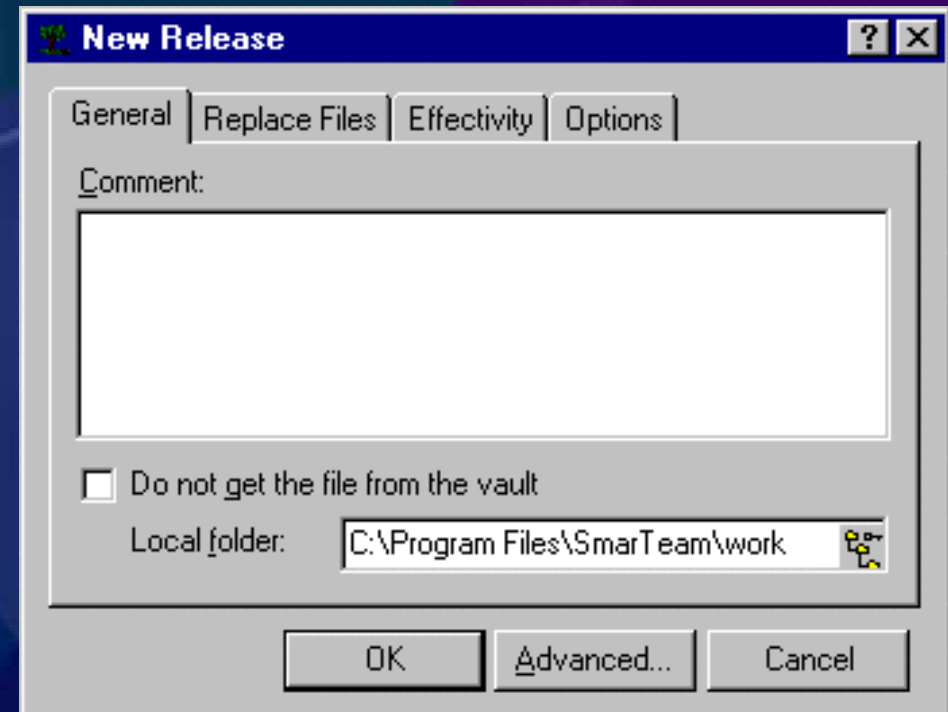
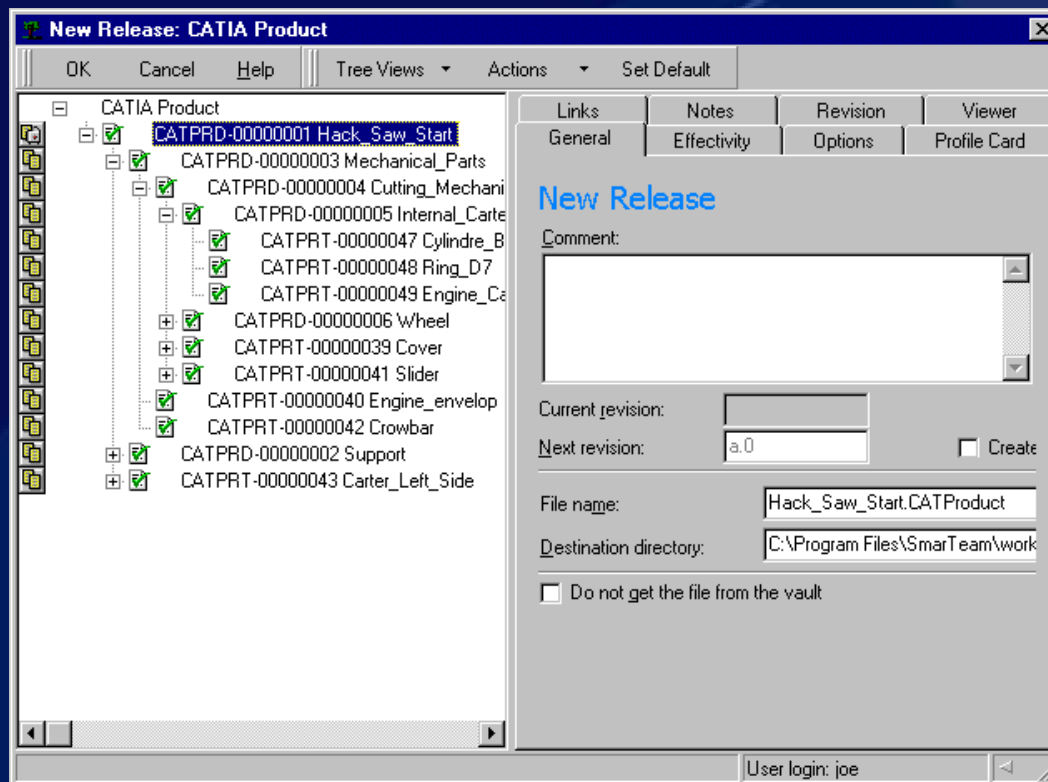

Easy-to-use interface:

Light Life Cycle process

- A more intuitive way to perform Life Cycle operations

Simplified menus and capabilities

- Menu editor : an option to configure the SmarTeam menus

Web Link from within SmarTeam to Better Support the Supply Chain

- Attachment of hyperlinks to any product data being managed by supply chain partners, giving users the ability to link to any URL for additional up-to-date information like detailed specifications, pricing, part numbers, etc. from within SmarTeam's Profile Card.

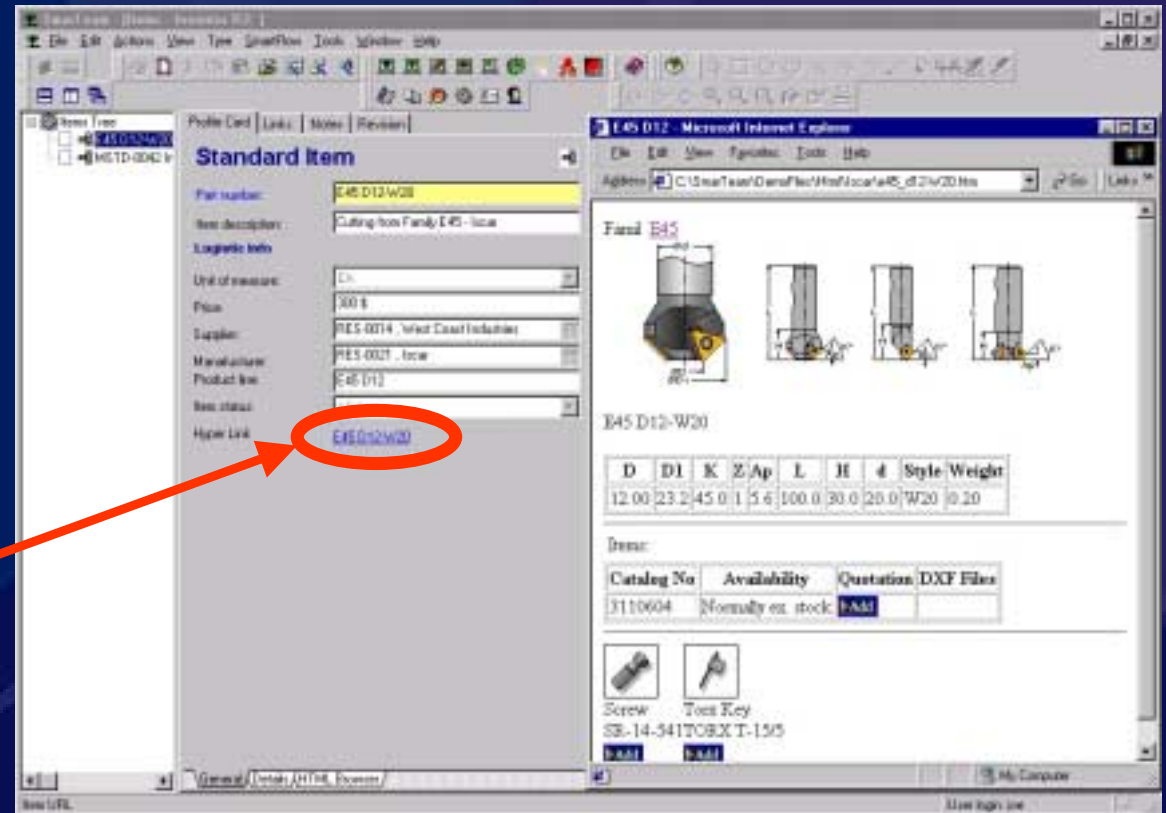

SmarTeam

Leading through collaboration

SmarTeam

Multi-CAD Strategy

- Provide seamlessly integrated PDM solutions to mainstream CAD and office applications in order to supply a common collaboration platform among engineering teams
- Create synergy between people, information, applications & business processes by providing an affordable easy-to-use data management solutions
- SmarTeam is integrated with the following leading PC-CAD applications: CATIA, SolidWorks, Solid Edge, AutoCAD, Mechanical Desktop, Autodesk Inventor, MicroStation and Cadkey

SmarTeam

Leading through collaboration

CAD Integrations

Integration between CAD systems and SmarTeam

- All CAD documents types can be saved in the database
- The CAD assemblies and parts properties are automatically saved in the SmarTeam database

Enhanced usability

- Preview of a document
- Ease the searches

Support for Windows NT,
Windows 98, Windows 2000

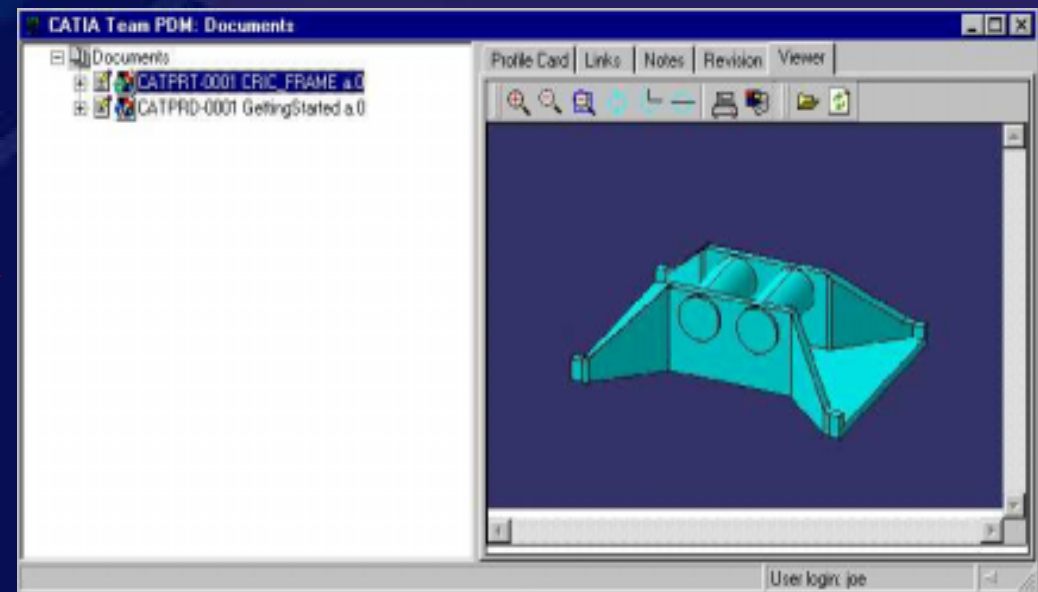
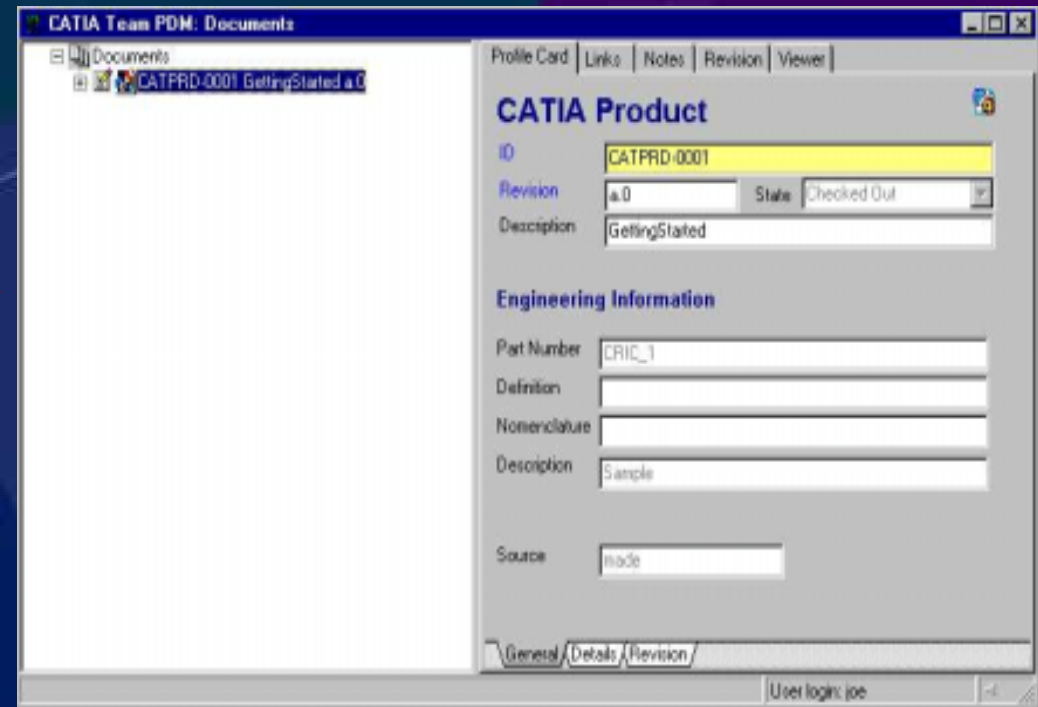

Usability Through Integrations

- Easy-to-learn and quick to use PDM solutions that integrate with the most popular CAD and office applications
- Using COM and DCOM technologies, CAD plug-ins are tightly integrated into any Windows CAD and office software
- “In Process” CAD integrations
- “In Process” benefits
 - users continue to work in their CAD design session environment
 - All key operations: Search, Locate and Life Cycle/Revision Control are executed from within the CAD
 - Users avoid re-keying redundant information

Full Assembly and Drawing Hierarchy Support

- Full Part and Assembly Management
 - Managing complex assemblies and their component parts
 - Keeping Absolute integrity of assembly hierarchy and its dependencies during life cycle operations
- Drawing Management
 - All aspects of drawing control are efficiently managed by SmarTeam's CAD integrations
 - Deep Title Block and Revision Block penetration and control
 - Bill of Materials integration and annotation mapping - This insures that the shop floor gets the RIGHT document ON TIME.

SmarTeam

Leading through collaboration

Properties Mapping

Properties mapping : visualization & query

- Extract CAD properties (such as mechanical properties ...)
- Fill CAD Properties from the database
 - Example: to fill in automatically a drawing title

The screenshot displays the CATIA Team PDM interface. On the left, a tree view shows 'Documents' with a sub-entry 'CATDRW-00000013 TitleBlockFrame'. The main area is divided into several panels:

- CATIA Drawing**: Contains fields for ID (CATDRW-00000013), Revision (empty), State (New), Description (TitleBlockFrame), and Drawing Title (Title Block).
- Title Block Information**: Contains Type (Frame) and Scale (empty).
- Viewer**: Shows a tree view of the drawing structure, including 'Sheet1', 'Isometric view', 'Front view', 'Section view A-A', and 'Section view B-B'.

A blue arrow points from the 'Drawing Title' field to a detailed view of a drawing title block. This view includes a 'REVISIONS' table and a title block with the following data:

REVISIONS			
Revision	Comment	Approval Date	Authorized
Rev.:	Com.:	Date:	Auth.:
Rev.:	Com.:	Date:	Auth.:
Rev.:	Com.:	Date:	Auth.:
Rev.:	Com.:	Date:	Auth.:

FORMAT	SCALE	NF E 27-494	APPLICABLE SPECS.	IND. ASSEMBLY	FINAL APPLICATION
A0	1:1				
APPROVALS					
BY	DATE	BY	DATE	TITLE	
MD				STOCK	
RE				FINISH	
QA					
REP				DATE	ISSUING NO.
DEM				Eng. CDK	REV.
				Created CDK	A 02457869G
				Checked CDK	D

Adding Value Through Functionality

- Full Assembly and Drawing hierarchy support
- Full *Xref* / Reference Files support
- Revision Control on single file or Assemblies
- Drawing, and file management –
ties together all product related information
- Easy search and documents retrieval
 - By any attribute (revision, description, part number etc.)
 - “Where Used” and “Composed of” queries
- Title Block and Revision Block integration
- Embedded viewer (over 200 formats)

SmarTeam

Leading through collaboration

SmarTeam Customization Tools 1

SmarTeam comes with a full set of customization tools allowing an administrator to customize every aspect of the system.

1. The Smart Wizard

A utility that allows administrators to define their own data model, customized to meet their companies own specific requirements.

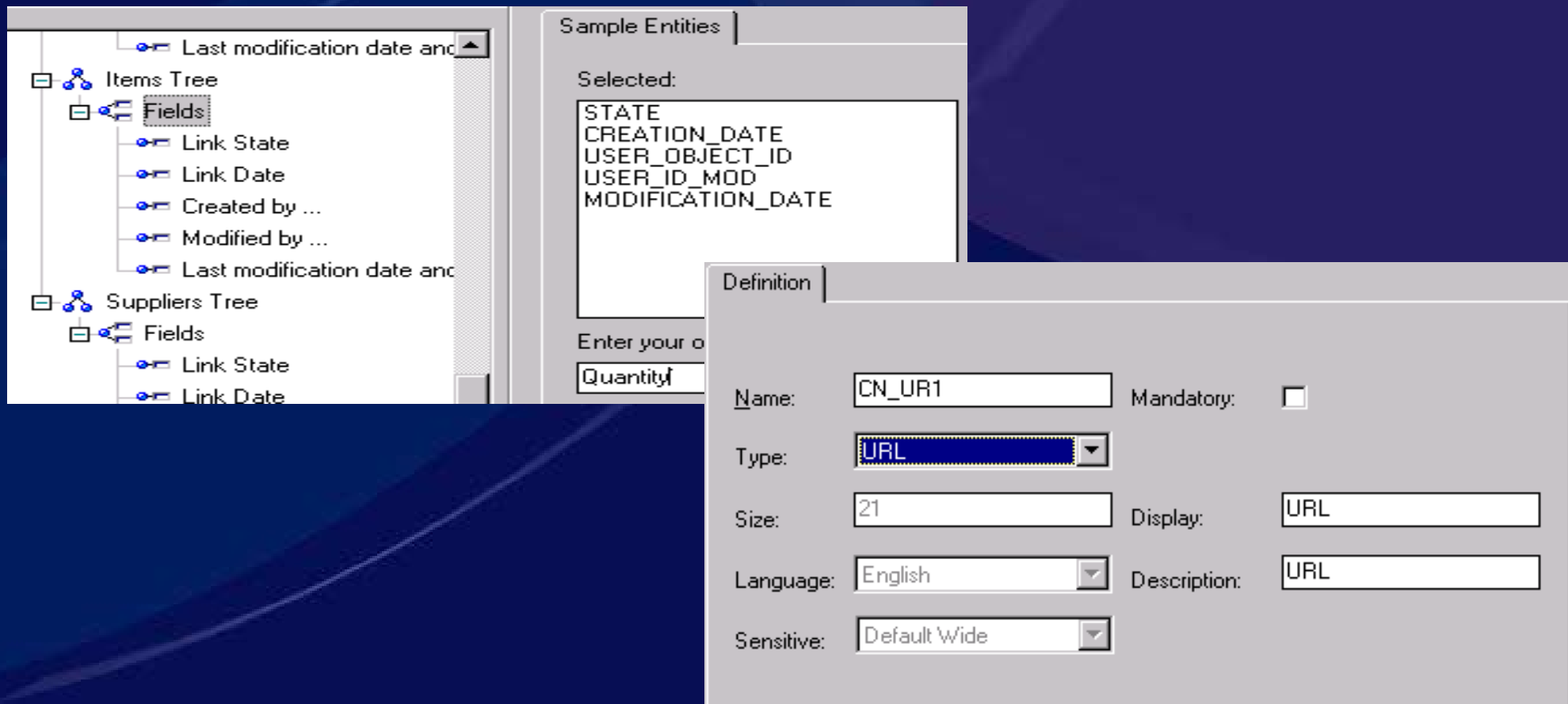

SmarTeam Customization Tools 2

- Form Designer
 - An intuitive tool allowing users to customize the look and feel of the user interface, this being the profile cards.

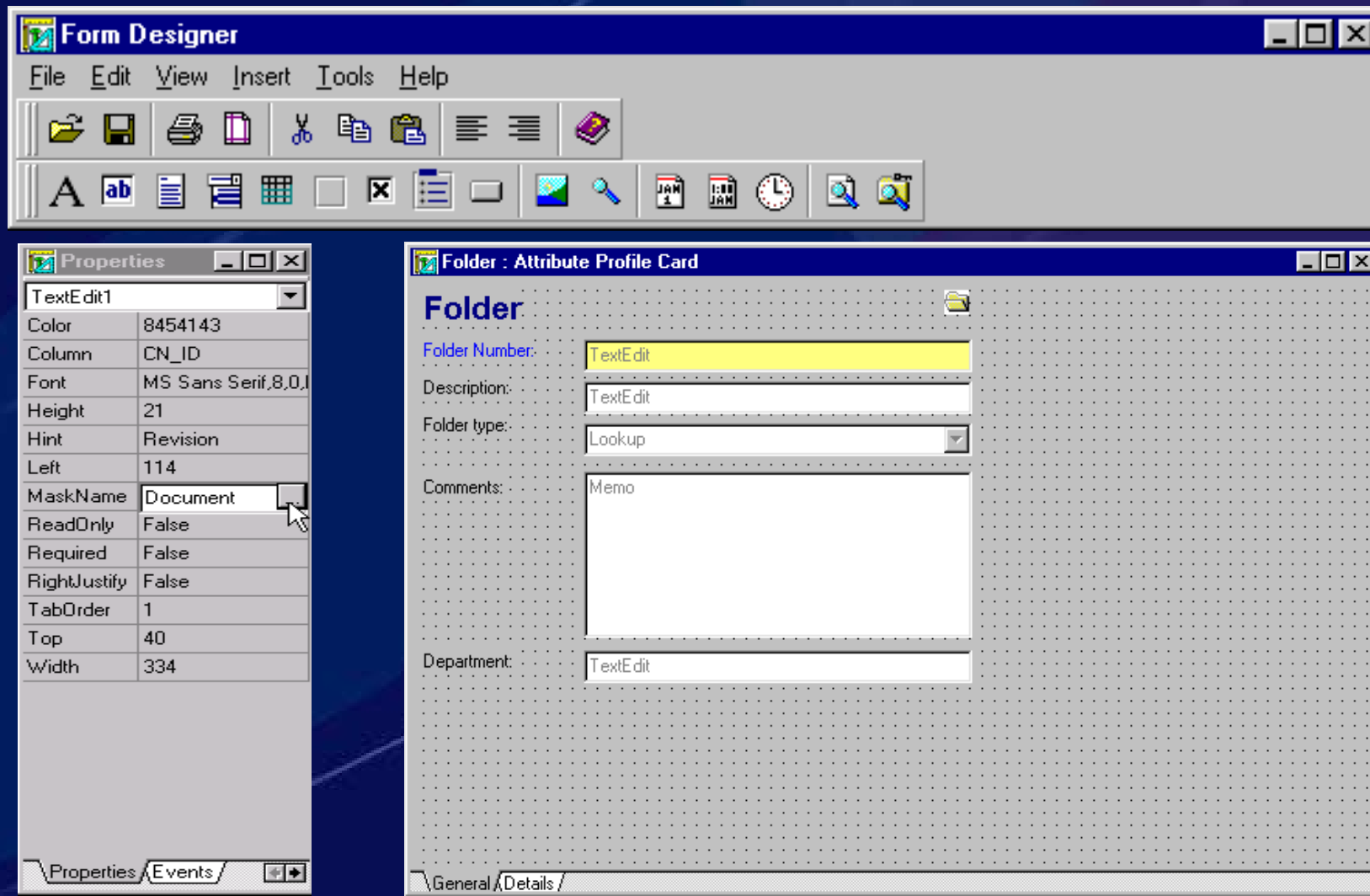

SmarTeam Customization Tools 3

- **Sequence Designer** – Define masks and incremental sequences for any field
- **User Maintenance** – Define authorizations for users and groups of users
- **Flow Chart Designer** – Define and design your own ECO, ECP, etc. Flow charts
- **Default Values** – Define default values for any field in the database
- **Menu Editor** – Customize the menus and toolbars according to a users logon to the system
- **Multi-Language** – Load or define a new language for the menus, toolbars and tool tips – I.e. translate SmarTeam or use one of the existing languages
- **Import/Export** – Import legacy data from another system or export SmarTeam Data

SmarTeam

Leading through collaboration

SmarTeam

www.smarteam.com

Leading
through
collaboration

SmarTeam

Leading through collaboration